

# SENCO®

## ***XP Heavy Staplers***

Operating Instructions  
Instrucciones de Operacion  
Mode d'Emploi



*Senco Products Inc.  
8485 Broadwell Road  
Cincinnati, Ohio 45244*



***SNS44XP***

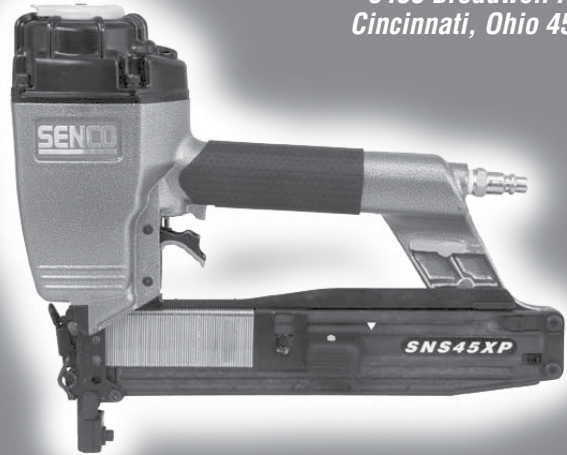

***SNS45XP***



***SNS50XP***



***SQS55XP***

*Questions? Comments?  
call Senco's toll-free Action-line: 1-800-543-4596  
or e-mail: [toolprof@senco.com](mailto:toolprof@senco.com) [www.senco.com](http://www.senco.com)*



Warnings for the safe use of this tool are included in this manual.  
Los avisos para el uso seguro de esta herramienta están incluidos en este manual.  
Les consignes pour l'utilisation en toute sécurité de cet outil se trouvent dans ce manuel.

© 2007 by Senco Products, Inc.

NFD83B587566 Revised November 5, 2007  
(Replaces January 8, 2007)

English	Español	Français
---------	---------	----------

TABLE OF CONTENTS	TABLA DE MATERIAS	TABLE DES MATIÈRES
-------------------	-------------------	--------------------

Tool Use	2	Utilisation de	
Maintenance	5	l'outil	2
Troubleshooting	6	Entretien	5
Accessories	6	Dépannage	6
Specifications	7	Accessoires	6
Options	8	Spécifications	7
		Options	8
		Especificaciones	7
		Opciones	8

EMPLOYER'S RESPONSIBILITIES	RESPONSABILIDADES DEL EMPLEADOR	RESPONSABILITÉS DE L'EMPLOYEUR
-----------------------------	---------------------------------	--------------------------------

<p>Employer must enforce compliance with the safety warnings and all other instructions which accompany this tool as shipped from the manufacturer.</p> <p>Keep this manual available for use by all people assigned to the use of this tool.</p> <p>For personal safety and proper operation of this tool, read and understand all of these instructions carefully.</p>	<p>El empleador debe hacer cumplir las advertencias de seguridad y todas las otras instrucciones que acompañan a esta herramienta como se la despacha desde el fabricante.</p> <p>Mantenga este manual disponible para que lo usen todas las personas destinadas a hacer uso de esta herramienta.</p> <p>Por razones de seguridad personal y la adecuada operación de esta herramienta, lea y comprenda todas estas instrucciones cuidadosamente.</p>	<p>L'employeur doit faire appliquer les consignes de sécurité et toutes les autres instructions qui accompagnent cet outil tel qu'il est livré par son constructeur.</p> <p>Ayez ce manuel à la disposition de toutes les personnes chargées d'utiliser cet outil.</p> <p>Pour assurer la sécurité personnelle et le bon emploi de cet outil, lisez et assimilez soigneusement toutes ces instructions.</p>
--	---	---

Tool Use	Uso de la Herramienta	Utilisation de l'Outil
English	Español	Français

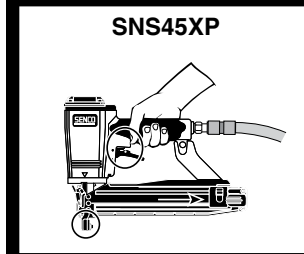
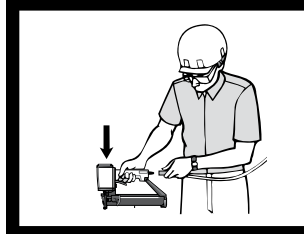
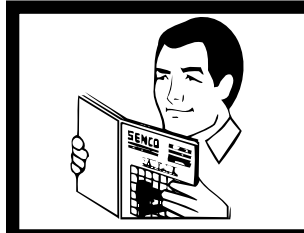

- |  |   |   |
|--|---|---|
| <ul style="list-style-type: none"> <li>● Read and understand "SAFETY INSTRUCTIONS" manual shipped with this tool before using tool.</li> </ul> | <ul style="list-style-type: none"> <li>● Antes de usar la herramienta lea y comprenda el manual "INSTRUCCIONES DE SEGURIDAD" despachado con ella.</li> </ul>    | <ul style="list-style-type: none"> <li>● Lisez et assimilez le manuel "INSTRUCTIONS DE SÉCURITÉ" livré avec cet outil avant de l'utiliser.</li> </ul>   |
| <ul style="list-style-type: none"> <li>● Keep tool pointed away from yourself and others and connect air to tool.</li> </ul>                   | <ul style="list-style-type: none"> <li>● Mantenga la herramienta apuntando en dirección opuesta de usted y de otros y conecte el aire a la manguera.</li> </ul> | <ul style="list-style-type: none"> <li>● Maintenez l'outil pointé à l'écart d'autres personnes et de vous-même et raccordez l'air à l'outil.</li> </ul> |
| <p><b>SNS45XP</b></p> <ul style="list-style-type: none"> <li>● To Load: Pull feeder shoe back into "locked" position.</li> </ul>               | <ul style="list-style-type: none"> <li>● Para cargar: Tire del alimentador hacia atrás hasta la posición "cerrada" ("locked").</li> </ul>                       | <ul style="list-style-type: none"> <li>● Pour charger : Tirez le poussoir en arrière dans la position "verrouillée" ("locked").</li> </ul>              |

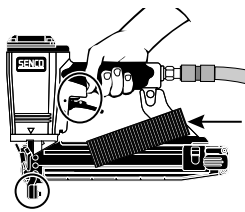
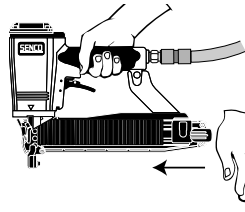
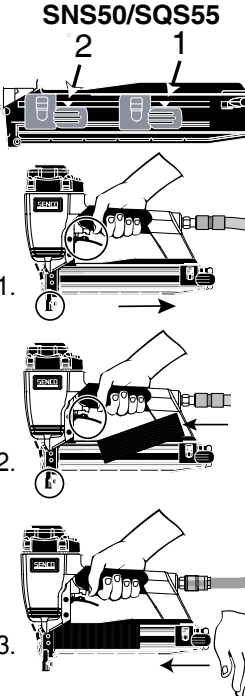
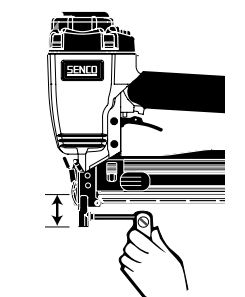
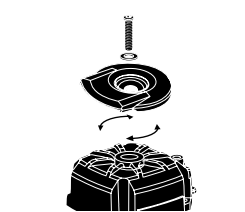
	Tool Use	Uso de la Herramienta	Utilisation de l'Outil
	English	Español	Français
	<ul style="list-style-type: none"> <li>● Lay strip of staples onto rail. Use only genuine SENCO fasteners. Do not load with safety element or trigger depressed.</li> </ul>	<ul style="list-style-type: none"> <li>● Ponga la tira sobre la guía. Use solamente sujetadores SENCO auténticos. No cargue con el disparo o la seguridad oprimidos.</li> </ul>	<ul style="list-style-type: none"> <li>● Mettez une bande de agrafes sur la traverse. Utilisez uniquement les véritables agrafes SENCO. Veillez à ne pas appuyer sur le palpeur de sécurité ou sur la détente quand vous chargez.</li> </ul>
	<ul style="list-style-type: none"> <li>● Tap feeder shoe and allow to slide forward.</li> </ul> <p><b>SNS44XP</b></p> <ul style="list-style-type: none"> <li>● Depress feeder shoe lock button and allow to slide forward.</li> </ul>	<ul style="list-style-type: none"> <li>● Empuje el alimentador hacia abajo y deslízelo hacia adelante.</li> </ul> <p><b>SNS44XP</b></p> <ul style="list-style-type: none"> <li>● Presione el botón de la cerradura del zapato del alimentador y permita para resbalar adelante.</li> </ul>	<ul style="list-style-type: none"> <li>● Poussez vers le bas le sabot du charger et faites-le glisser en avant.</li> </ul> <p><b>SNS44XP</b></p> <ul style="list-style-type: none"> <li>● Enfoncez le bouton de serrure de chaussure de conducteur et laissez glisser en avant.</li> </ul>
<p><b>SNS50/SQS55</b></p> 	<ul style="list-style-type: none"> <li>● To Load: When the feeder shoe aligns with the reload indicator, additional fasteners (1 or 2 strips) can be loaded.</li> </ul> <ol style="list-style-type: none"> <li>1. Pull feeder shoe back into "locked" position.</li> <li>2. Lay strip of staples onto rail. Use only genuine SENCO fasteners. Do not load with workpiece contact (safety element) or trigger depressed.</li> <li>3. Tap feeder shoe and allow to slide forward.</li> </ol>	<ul style="list-style-type: none"> <li>● Para cargar: Cuando el alimentador se alinea con el indicador de recarga, sujetadores adicionales (1 o 2 tiras) pueden cargarse.</li> </ul> <ol style="list-style-type: none"> <li>1. Tire del alimentador hacia atrás hasta la posición "cerrada" ("locked").</li> <li>2. Ponga la tira sobre la guía. Use solamente sujetadores SENCO auténticos. No cargue con el disparo o la seguridad oprimidos.</li> <li>3. Empuje el alimentador hacia abajo y deslízelo hacia adelante.</li> </ol>	<ul style="list-style-type: none"> <li>● Pour charger : Quand le pousse agrafes est aligné avec l'indicateur de rechargement, des agrafes supplémentaires peuvent être ajoutées. ( 1 ou 2 bandes)</li> </ul> <ol style="list-style-type: none"> <li>1. Tirez le poussoir en arrière dans la position "verrouillée" ("locked").</li> <li>2. Mettez une bande de agrafes sur la traverse. Utilisez uniquement les véritables agrafes SENCO. Veillez à ne pas appuyer sur le palpeur de sécurité ou sur la détente quand vous chargez.</li> <li>3. Poussez vers le bas le sabot du charger et faites-le glisser en avant.</li> </ol>
	<ul style="list-style-type: none"> <li>● This tool is equipped with a depth control workpiece contact (safety element). To adjust the depth of the staple being driven, loosen the screw and slide the lower workpiece contact up or down and lock in place by tightening the screw. Be sure the workpiece contact moves freely after adjustment. A malfunctioning workpiece contact can cause a fastener to be discharged accidentally.</li> </ul>	<ul style="list-style-type: none"> <li>● Esta herramienta esta equipada con un elemento de seguro para control de profundidad. Para ajustar la profundidad del engrapado. Afloje el tornillo y deslice el elemento de seguridad hacia arriba o abajo a la posición deseada y aprieta el tornillo. Asegúrese que elemento de seguro tenga movimiento libre después de ajustarse. Un elemento de seguro en mal estado puede causar que un sujetador sea descargado accidentalmente.</li> </ul>	<ul style="list-style-type: none"> <li>● Cet appareil est équipé d'un réglage de profondeur d'agrafage. Pour effectuer le réglage de la penetration de l'agrafe, desserrer la vis et faire glisser vers le haut ou vers le bas la partie inférieure du palpeur de sécurité. Le bloquer ensuite en position par l'intermédiaire de la vis. Assurez-vous après cette opération que l'élément de sécurité peut coulisser librement.</li> </ul>
	<ul style="list-style-type: none"> <li>● The deflector can be rotated to change the direction of the exhaust air. Disconnect air supply, loosen cap screw with a socket head cap screw wrench, and then rotate deflector to desired location. Tighten cap screw.</li> </ul>	<ul style="list-style-type: none"> <li>● El deflector puede rotarse para cambiar la dirección del aire expedido por el mofle. Desconecte el aire, afloje los tornillos de la tapa y porte el deflector a la posición deseada. Apriete los tornillos de la tapa.</li> </ul>	<ul style="list-style-type: none"> <li>● Le déflecteur peut être orienté différemment pour changer la direction de l'échappement d'air. Déconnecter l'appareil de la source d'air comprimé, dévisser la vis de maintien du déflecteur et faire pivoter celui-ci jusqu'à la position voulue. Resserrer la vis de maintien.</li> </ul>

English

Español

Français

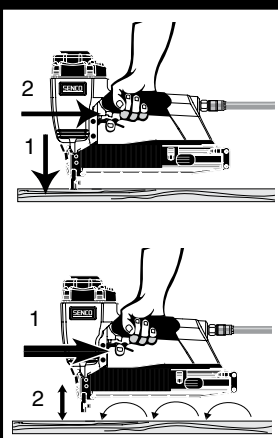

- With a "Contact -Actuation" (Dual-Action) trigger, nails can be driven two ways:
  - a) Position workpiece contact (safety element) against work surface and pull trigger..."Trigger Fire."
  - b) To drive a nail, pull trigger and push workpiece contact against work surface. Each time the workpiece contact is pushed against the work surface a nail will be driven. This "bottom-fire" mode of operation is preferred when high production, rapid fastener placement is desired.

- Las herramientas con gatillo de accion doble pueden ser disparadas de dos maneras:
  - a) Oprima el seguro contra la superficie de trabajo y apriete el gatillo...Disparo de gatillo.
  - b)Para impulsar un clavo, oprima el disparador y deprima el elemento de seguridad contra la superficie de trabajo. Cada vez que deprima el elemento de seguridad contra la superficie de trabajo contra la superficie de trabajo. Cada vez que deprima el elemento de seguridad contra la superficie de trabajo un clavo será impulsado. Este modo de operación de "disparo inferior" o "por rebote" es el preferido cuando se desea alta productividad y rápida colocación del clavo.

- Les appareils équipés de déclenchement "au touché / par gâchette" peuvent être utilisés de 2 façons différentes :
  - a) Déclenchement par "gâchette" : Appliquer le palpeur de sécurité de l'appareil à l'endroit désiré et activer la gâchette.
  - b)Pour planter un clou, tirez sur la détente et poussez l'élément de sécurité contre la surface de travail. Chaque fois que l'élément de sécurité est poussé contre la surface de travail un clou est planté. Le mode de fonctionnement en "tir continu" est préférable si vous désirez placer des attaches rapidement avec forte productivité.

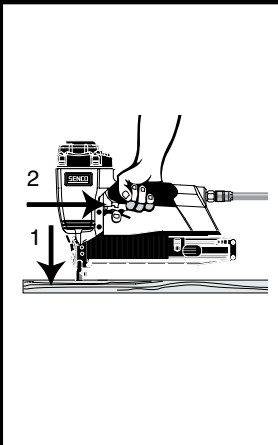

- With a "Sequential" (Restrictive) trigger, nails can only be driven one way. First depress workpiece contact (safety element) against work surface then pull trigger. This feature is helpful when precise fastener placement is required. Read the "Customer Satisfaction and Safety Reminder" (CSSR) in the tool and fastener boxes for safety information regarding the Contact-Actuation and Sequential triggers. Under certain conditions, the Sequential trigger may reduce the possibility of injury to you or to others working with you.

- Las herramientas con "Gatillo Restringido" solamente se pueden disparar con el gatillo. Primero apriete el elemento de seguridad contra la superficie de trabajo y después tire del gatillo. Ésta característica es útil cuando se requiere precisión en la colocación de los sujetadores. Lea el "Recordatorio de Seguridad y Satisfacción del Cliente" (CSSR) en las cajas de sujetadores y de las herramientas para información sobre seguridad de los Gatillos Restringido y de Acción Dual. Bajo ciertas condiciones, el Gatillo Restringido puede reducir la posibilidad de heridas a su persona o a otros que trabajen con usted.

- Avec une gâchette "restrictive", les clous ne peuvent être tirés que dans une seule direction. Appuyer d'abord le palpeur de sécurité sur la surface de travail, puis tirer sur la gâchette. Cette fonction est utile pour un placement précis de projectiles. Lire le "Rappel de Sécurité et Satisfaction du Client" (CSSR) dans les boîtes à outils et fixations pour les informations de sécurité concernant les Détonnes à Double Action et à Restriction. Dans certaines circonstances, la Détonne à Restriction peut réduire la possibilité de se blesser ou de blesser d'autres personnes.

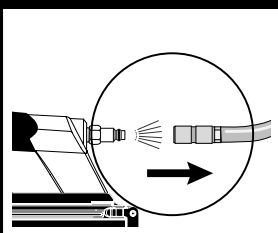

- Should a staple jam occur, disconnect air supply.

- Si se produce un atascamiento de las sujetadores, desconecte el suministro de aire.

- Si un enrayage se produit, coupez l'arrivée d'air.

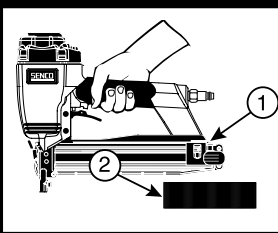

- Pull feeder shoe back into "locked" position and remove staples. Tap feeder shoe and allow to slide forward.

**SNS44XP**

- Depress feeder shoe lock button and allow to slide forward.

- Tire del alimentador hacia atrás a la posición "cerrada (locked)" y remueva las grapas. Empuje el alimentador hacia abajo y deslícelo hacia adelante.

**SNS44XP**

- Presione el botón de la cerradura del zapato del alimentador y permita para resbalar adelante.

- Tirez en arrière le sabot du chargeur dans la position de "verrouillage" et enlevez les projectiles. Poussez vers le bas le sabot du chargeur et faites-le glisser en avant.

**SNS44XP**

- Enfoncez le bouton de serrure de chaussure de conducteur et laissez glisser en avant.

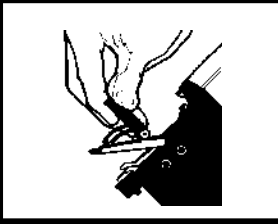

- Release E-Z Clear latch and open door.

- Suelte el pestillo de alivio fácil (E-Z) y abra la puerta.

- Relâchez le loquet transparent "E-Z" et ouvrez le volet de front.

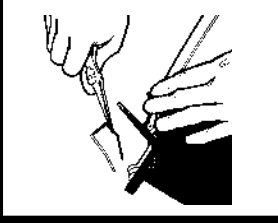

- Remove jammed fastener. Close door and latch.

- Remueva el sujetador atascado. Cierre la puerta con pestillo.

- Enlevez le projectile coincé. Fermez le volet de front et le loquet.

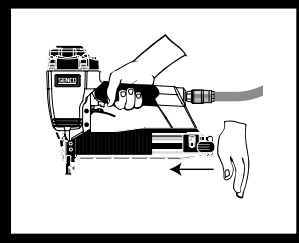
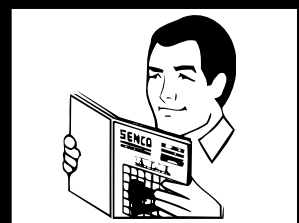
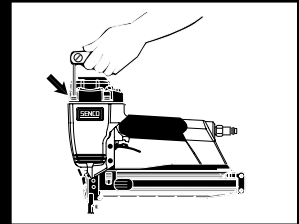
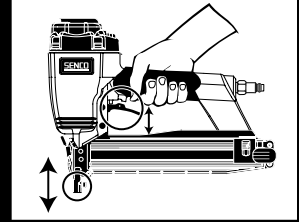
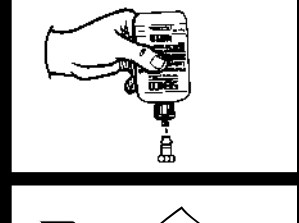
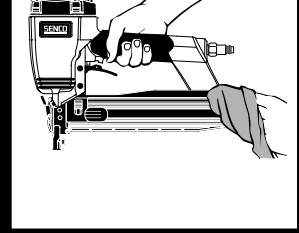
		Tool Use	Uso de la Herramienta	Utilisation de l'Outil
		English	Español	Français
	<ul style="list-style-type: none"> <li>● Connect air supply and replace fasteners. Tap feeder shoe and allow to slide forward.</li> </ul>	<ul style="list-style-type: none"> <li>● Conecte la línea de aire y reemplace los sujetadores. Empuje el alimentador hacia abajo y deslícelo hacia adelante.</li> </ul>	<ul style="list-style-type: none"> <li>● Reconnectez la conduit d'air comprimé et rechargez le magasin. Poussez vers le bas le sabot du chargeur et faites-le glisser en avant.</li> </ul>	
			Maintenance	Mantenimiento
		English	Español	Français
	<ul style="list-style-type: none"> <li>● Read and understand "SAFETY INSTRUCTIONS" manual shipped with this tool before using tool.</li> </ul>	<ul style="list-style-type: none"> <li>● Antes de usar la herramienta lea y comprenda el manual "INSTRUCCIONES DE SEGURIDAD" despachado con ella.</li> </ul>	<ul style="list-style-type: none"> <li>● Lisez et assimilez le manuel "INSTRUCTIONS DE SÉCURITÉ" livré avec cet outil avant de l'utiliser.</li> </ul>	
	<ul style="list-style-type: none"> <li>● All screws should be kept tight. Loose screws result in unsafe operation and parts breakage.</li> </ul>	<ul style="list-style-type: none"> <li>● Todos los tornillos tienen que mantenerse apretados. Los tornillos sueltos pueden producir una operación no segura y quebraduras de partes.</li> </ul>	<ul style="list-style-type: none"> <li>● L'outil étant séparé de l'alimentation en air, effectuez une inspection journalière pour assurer le libre mouvement du palpeur de sécurité et de la détente. N'utilisez pas l'outil si le palpeur de sécurité ou la détente colle ou se coince.</li> </ul>	
	<ul style="list-style-type: none"> <li>● With tool disconnected, make daily inspection to assure free movement of workpiece contact (safety element) and trigger. Do not use tool if workpiece contact or trigger sticks or binds.</li> </ul>	<ul style="list-style-type: none"> <li>● Con la herramienta desconectada, haga inspecciones diarias para asegurar el movimiento libre del seguro y del gatillo. No use la herramienta si el seguro o el gatillo se atorán.</li> </ul>	<ul style="list-style-type: none"> <li>● Toutes les vis doivent être maintenues serrées à fond. Les vis desserrées entraînent un manque de sûreté du fonctionnement et la rupture de pièces.</li> </ul>	
	<ul style="list-style-type: none"> <li>● Squirt Senco pneumatic oil (5 to 10 drops) into the air inlet twice daily. (Depending on frequency of tool use.) Other oils may damage O-rings and other tool parts.</li> </ul>	<ul style="list-style-type: none"> <li>● Aplique aceite neumático Senco en la entrada de aire dos veces al día. (Dependiendo en la frecuencia de uso 5 A 10 Gotas.) Otros aceites pueden dañar los anillos en "O" y otras piezas de la herramienta.</li> </ul>	<ul style="list-style-type: none"> <li>● Avec une burette, placer 5 à 10 gouttes d'huile pneumatique dans l'arrivée d'air deux fois par jour. (Dépend de l'intensité de l'utilisation de l'appareil.) D'autres huiles pourraient endommager les joints toriques et d'autres pièces de l'outil.</li> </ul>	
	<ul style="list-style-type: none"> <li>● Wipe tool clean daily and inspect for wear. Use non-flammable cleaning solutions only if necessary – DO NOT SOAK. CAUTION: Such solutions may damage O-rings and other tool parts.</li> </ul>	<ul style="list-style-type: none"> <li>● Solamente si es necesario use soluciones para limpieza no inflamables -NO LA REMOJE. Precaución: Tales soluciones pueden dañar los empaques y otras partes de la herramienta.</li> </ul>	<ul style="list-style-type: none"> <li>● Nettoyez l'outil chaque jour à l'aide d'un chiffon et inspectez-le pour décélérer une éventuelle usure. Utilisez uniquement des solvants non inflammables en cas de nécessité – NE LE FAITES PAS TREMPER! Attention : De tels produits peuvent endommager les joints et d'autres pièces de l'appareil.</li> </ul>	

Troubleshooting	Identificación de Fallas	Dépannage
English	Español	Français

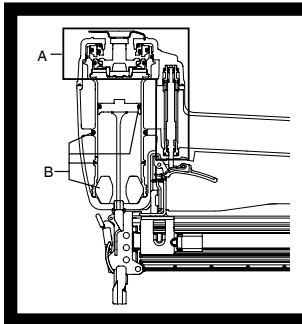

**WARNING**  
Repairs other than those described here should be performed only by trained, qualified personnel. Contact SENCO for information at 1-800-543-4596.

- Read and understand "SAFETY INSTRUCTIONS" manual shipped with this tool before using tool.

**ALERTA**  
Las reparaciones, fuera de aquellas descritas aquí, deben de ser llevadas a cabo solamente por personal entrenado y calificado. Póngase en contacto con SENCO para información 1-800-543-4596.

- Antes de usar la herramienta lea y comprenda el manual "INSTRUCCIONES DE SEGURIDAD" despachado con ella.

**AVERTISSEMENT**  
Les réparations autres que celles décrites ici doivent être réalisées uniquement par du personnel qualifié ayant reçu la formation appropriée. Pour toute information, prenez contact avec SENCO par téléphone en appelant Le Distributeur agréé.

- Lisez et assimilez le manuel "INSTRUCTIONS DE SÉCURITÉ" livré avec cet outil avant de l'utiliser.

KIT #	A	B
SNS44XP	YK0421	-
SNS45XP	YK0230	YK0231
SNS50XP	YK0375	YK0375
SQS55XP	YK0375	YK0375

**SYMPTOM**  
Air leak near top of tool / Sluggish operation

**SOLUTION**  
Verify air supply / tighten screws or install Parts Kit A.

**SÍNTOMA**  
El aire se escapa cerca de la parte superior de la herramienta / Operación lenta.

**SOLUCIÓN**  
Apriete los tornillos / Verifique el suministro de aire o instale el Juego de Partes A (Parts Kit A).

**SYMPTÔME**  
Fuite d'air près du sommet de l'outil / fonctionnement lent.

**SOLUTION**  
Serrez les vis à fond / vérifiez l'alimentation en air ou remplacez les pièces portant la lettre "A".

**SYMPTOM**  
Air leak near bottom of tool / Poor return.

**SOLUTION**  
Clean tool / tighten screws or install Parts Kit B.

**SÍNTOMA**  
El aire se fuga cerca de la parte inferior de la herramienta / Mal retorno.

**SOLUCIÓN**  
Apriete los tornillos / Limpié la herramienta o instale el Juego de Partes B (Parts Kit B).

**SYMPTÔME**  
Fuite d'air près de la base de l'outil / retour inadéquat.

**SOLUTION**  
Serrez les vis à fond / nettoyez l'outil ou remplacez les pièces portant la lettre "B"

**SYMPTOM**  
Other problems.

**SOLUTION**  
Contact SENCO.

**SÍNTOMA**  
Otros problemas.

**SOLUCIÓN**  
Póngase en contacto con SENCO.

**SYMPTÔME**  
Autres problèmes.

**SOLUTION**  
Prenez contact avec SENCO.

Accessories	Accesorios	Accessoires
English	Español	Français

SENCO offers a full line of accessories for your SENCO tools, including:

- Air Compressors
- Hose
- Couplers
- Fittings
- Safety Glasses
- Pressure Gauges
- Lubricants
- Regulators
- Filters

For more information or a complete illustrated catalogue of SENCO accessories, ask your representative for #MK336.

SENCO ofrece una línea completa de Accesorios para sus herramientas SENCO, incluyendo:

- Compresores de Aire
- Manguera
- Conectores Rápidos
- Conectores
- Anteojos De Seguridad
- Manómetros
- Lubricantes
- Reguladores
- Filtros

Para mas informacion ó un pour recevoir un catalogo completo ilustrado de los Accesorios SENCO, pregunte a su representante para el numero MK336.

SENCO offre une gamme étendue d'accessoires pour vos outils SENCO y compris :

- Compresseurs
- Tuyauterie flexible
- Raccords
- Lunettes de sécurité
- Manomètres
- Lubrifiants
- Régulateurs
- Filtres

Pour plus d'informations ou pour recevoir un catalogue détaillé des accessoires proposés par SENCO, prenez contact avec votre représentant SENCO (référence catalogue : #MK336).

**SNS44XP/45XP**

Specifications English	Especificaciones Español	Specifications Français
---------------------------	-----------------------------	----------------------------

Code	A	
	inches	mm
N13	1	25
N14	1 1/8	29
N15	1 1/4	32
N16	1 3/8	35
N17	1 1/2	38
N18	1 5/8	41
N19	1 3/4	44
N21*	2	50

\*SOFTWOOD APPLICATIONS ONLY  
\*SOLO PARA APLICACIONES EN MADERA BLANDA  
\*UNIQUEMENT DANS DU BOIS TENDRE

**SNS50XP**

Specifications English	Especificaciones Español	Specifications Français
---------------------------	-----------------------------	----------------------------

Code	A	
	inches	mm
N15	1 1/4	32
N16	1 3/8	35
N17	1 1/2	38
N18	1 5/8	41
N19	1 3/4	44
N21	2	50

**SQS55XP**

Specifications English	Especificaciones Español	Specifications Français
---------------------------	-----------------------------	----------------------------

Code	A	
	inches	mm
Q15	1 1/4	32
Q17	1 1/2	38
Q19	1 3/4	44
Q21	2	50
Q23	2 1/4	57
Q25	2 1/2	65

English TECHNICAL SPECIFICATIONS	SNS44XP		SNS45XP		SNS50XP		SQS55XP	
Minimum to maximum operating pressure	80–120 psi	5,5–8,3 bar	80–120 psi	5,5–8,3 bar	80–120 psi	5,5–8,3 bar	80–120 psi	5,5–8,3 bar
Air Consumption (60 cycles per minute)	6.31 scfm	178 liter	5.52 scfm	156 liter	6.54 scfm	185 liter	6.54 scfm	185 liter
Air Inlet	3/8 in. NPT	3/8 in. NPT	3/8 in. NPT	3/8 in. NPT	3/8 in. NPT	3/8 in. NPT	3/8 in. NPT	3/8 in. NPT
Maximum Speed (cycles per second)	12	12	15	15	15	15	15	15
Weight	4.5 lbs.	2.0 kg	5.1 lbs.	2.3 kg	5.9 lbs.	2.7 kg	5.9 lbs.	2.7 kg
Staple Capacity	160	160	160	160	160	160	130	130
Tool size: Height	11 in.	279 mm	11 in.	279 mm	12 in.	305 mm	12 in.	305 mm
Tool size: Length	15 in.	381 mm	14 in.	356 mm	14 3/8 in.	365 mm	14 3/8 in.	365 mm
Tool size: Width: Main Body	3 1/4 in.	82 mm	3 1/2 in.	90 mm	3 5/8 in.	92 mm	3 5/8 in.	92 mm
Tool size: Width: Rear Bracket	–	–	–	–	–	–	–	–

Español ESPECIFICACIONES TECNICAS	SNS44XP		SNS45XP		SNS50XP		SQS55XP	
Presión de operación mínima y máxima	80–120 psi	5,5–8,3 bar	80–120 psi	5,5–8,3 bar	80–120 psi	5,5–8,3 bar	80–120 psi	5,5–8,3 bar
Consumo de aire (60 ciclos por minuto)	6.31 scfm	178 liter	5.52 scfm	156 liter	6.54 scfm	185 liter	6.54 scfm	185 liter
Entrada de aire	3/8 in. NPT	3/8 in. NPT	3/8 in. NPT	3/8 in. NPT	3/8 in. NPT	3/8 in. NPT	3/8 in. NPT	3/8 in. NPT
Velocidad máxima (ciclos por segundo)	12	12	15	15	15	15	15	15
Peso	4.5 lbs.	2.0 kg	5.1 lbs.	2.3 kg	5.9 lbs.	2.7 kg	5.9 lbs.	2.7 kg
Capacidad de grapas por cargador	160	160	160	160	160	160	130	130
Tamaño de la herramienta: Altura	11 in.	279 mm	11 in.	279 mm	12 in.	305 mm	12 in.	305 mm
Tamaño de la herramienta: Longitud	15 in.	381 mm	14 in.	356 mm	14 3/8 in.	365 mm	14 3/8 in.	365 mm
Tamaño de la herramienta: Ancho (Cuerpo)	3 1/4 in.	82 mm	3 1/2 in.	90 mm	3 5/8 in.	92 mm	3 5/8 in.	92 mm
Tamaño de la herramienta: Ancho (Brazo)	–	–	–	–	–	–	–	–

Français SPECIFICATIONS TECHNIQUES	SNS44XP		SNS45XP		SNS50XP		SQS55XP	
Pression de travail min. et max.	80–120 psi	5,5–8,3 bar	80–120 psi	5,5–8,3 bar	80–120 psi	5,5–8,3 bar	80–120 psi	5,5–8,3 bar
Consommation d'air (60 cycles par minute)	6.31 scfm	178 liter	5.52 scfm	156 liter	6.54 scfm	185 liter	6.54 scfm	185 liter
Prise d'air	3/8 in. NPT	3/8 in. NPT	3/8 in. NPT	3/8 in. NPT	3/8 in. NPT	3/8 in. NPT	3/8 in. NPT	3/8 in. NPT
Vitesse maximum (cycles par seconde)	12	12	15	15	15	15	15	15
Poids	4.5 lbs.	2.0 kg	5.1 lbs.	2.3 kg	5.9 lbs.	2.7 kg	5.9 lbs.	2.7 kg
Capacité de agrafes par magasin	160	160	160	160	160	160	130	130
Dimensions de l'outil: hauteur	11 in.	279 mm	11 in.	279 mm	12 in.	305 mm	12 in.	305 mm
Dimensions de l'outil: longueur	15 in.	381 mm	14 in.	356 mm	14 3/8 in.	365 mm	14 3/8 in.	365 mm
Dimensions de l'outil: largeur: corps de l'appareil	3 1/4 in.	82 mm	3 1/2 in.	90 mm	3 5/8 in.	92 mm	3 5/8 in.	92 mm
Dimensions de l'outil: largeur: console du magasin	–	–	–	–	–	–	–	–

Options English	Opciones Español	Options Français
<ul style="list-style-type: none"> <li>● RESTRICTIVE TRIGGER— This feature is helpful when precise fastener placement is required.</li> </ul>	<ul style="list-style-type: none"> <li>● GATILLO RESTRINGIDO— Esta característica sirve de ayuda cuando se requiere una colocación del sujetador precisa.</li> </ul>	<ul style="list-style-type: none"> <li>● DECLÉNCHEMENT PAR GACHETTE— Cette caractéristique s'avère utile quand un placement de projectiles précis s'impose.</li> </ul>



# Limited Warranty

## SENCO® Pneumatic, DuraSpin®, Cordless Tools & Compressors

Senco Products, Inc. ("SENCO") designs and constructs its products using the highest standards of material and workmanship. SENCO warrants to the original retail purchaser that the following products will be free from defects in material or workmanship for the warranty period specified below:

SENCO® XP Series-Red Cap Five years	SENCO PRO Series One year	SENCO Compressors One year
SENCO® XP Series-Black Cap Two Years	SENCO DuraSpin® One year	SENCO Cordless Two years
SENCO FP502 Two Years	SENCO Reconditioned Products One Year	

During the warranty period (which begins on the purchase date), SENCO will repair or replace, at SENCO's option and expense, any product or part that is defective in materials or workmanship after examination by a SENCO Authorized Warranty Service Center, subject to the exceptions, exclusions and limitations described below. Any replacement product or part will carry a warranty for the balance of the warranty period applicable to the replaced product or part. A DATED SALES RECEIPT OR PROOF OF PURCHASE FROM THE ORIGINAL RETAIL PURCHASER IS REQUIRED TO MAKE A WARRANTY CLAIM. Warranty registration also is required and can be accomplished through on-line Product Registration at [www.senco.com](http://www.senco.com) or by completing and returning the postage paid warranty registration form included with your Operator's manual/parts chart information, found inside the product carton. To make a warranty claim, you must return the product, with proper receipt/proof of purchase and return transportation charges prepaid, to a SENCO Authorized Warranty Service Center. A list of SENCO Authorized Warranty Service Centers can be found at [www.senco.com](http://www.senco.com) or by calling 1-800-543-4596 toll free. SENCO will perform its obligations under this warranty, within a reasonable time after approval of the warranty claim.

### Wheelbarrow Compressors:

- Subject to the exceptions, exclusions and limitations described below, SENCO warrants that the compressor pump will be free from defects in materials and workmanship for two years after the purchase date.
- Defective parts of the compressor pump not subject to normal wear and tear will be repaired or replaced, at SENCO's option, during the two year warranty period. If SENCO determines that repair or replacement is not feasible, SENCO will refund the purchase price less reasonable depreciation based on actual use.

### SENCO Cordless:

- Subject to the exceptions, exclusions and limitations described below, SENCO warrants that the SENCO Cordless tool will be free from defects in materials and workmanship for two years after the purchase date.
- Subject to the exceptions, exclusions and limitations described below, SENCO warrants that the batteries and chargers used with SENCO Cordless tools will be free from defects in material and workmanship for one year after the purchase date.

### WARRANTY EXCLUSIONS

The following warranty exclusions apply:

- Normal wear parts are not covered under this warranty. Normal wear parts include, for example, isolators, drive belts, air filters, rubber o-rings, seals, driver blades, piston stops, and piston/driver assembly.
- This warranty does not cover parts damaged due to normal wear, misapplication, misuse, accidents, operation at other than recommended speeds or voltage (electric units only), improper storage, or damage resulting during shipping.
- Products used in production/industrial applications as defined by SENCO are excluded from this warranty.
- Labor charges or loss or damage resulting from improper operation, maintenance or repairs are not covered by this warranty.
- SENCO does not warrant the Wheelbarrow Compressor Engine/Motor, but the Compressor Engine/Motor may be covered under a warranty offered by its manufacturer.

### GENERAL WARRANTY CONDITIONS

This warranty will be honored, only if:

- Clean, dry, regulated compressed air has been used, at air pressure not exceeding the maximum indicated on the tool casting;
- No evidence of abuse, abnormal conditions, accident, neglect, misuse or improper modifications or storage of the product; and
- No Deviation from operating instructions, specifications, and maintenance schedules exists (read Operator Manual for use, specifications, and maintenance instructions).

THIS WARRANTY IS THE ONLY WARRANTY ON THE PRODUCT, AND SENCO DISCLAIMS ALL OTHER WARRANTIES. ANY IMPLIED WARRANTIES WILL BE LIMITED IN DURATION TO THE APPLICABLE WARRANTY PERIOD SPECIFIED ABOVE. SOME STATES DO NOT ALLOW LIMITATIONS ON HOW LONG AN IMPLIED WARRANTY LASTS, SO THE ABOVE LIMITATION MAY NOT APPLY TO YOU. YOUR REMEDIES ARE SOLELY AND EXCLUSIVELY AS STATED ABOVE. SENCO SHALL IN NO EVENT BE LIABLE FOR INCIDENTAL, CONSEQUENTIAL, INDIRECT, OR SPECIAL DAMAGES. SOME STATES DO NOT ALLOW THE EXCLUSION OR LIMITATION OF INCIDENTAL OR CONSEQUENTIAL DAMAGES, SO THE ABOVE LIMITATION OR EXCLUSION MAY NOT APPLY TO YOU. IN NO EVENT, WHETHER AS A RESULT OF A BREACH OF CONTRACT, WARRANTY, TORT (INCLUDING NEGLIGENCE) OR OTHERWISE, SHALL SENCO'S LIABILITY EXCEED THE PRICE OF THE PRODUCT WHICH HAS GIVEN RISE TO THE CLAIM OR LIABILITY. ANY LIABILITY CONNECTED WITH THE USE OF THIS PRODUCT SHALL TERMINATE UPON THE EXPIRATION OF THE WARRANTY PERIOD SPECIFIED ABOVE. NO EMPLOYEE OR REPRESENTATIVE OF SENCO OR ANY DISTRIBUTOR OR DEALER IS AUTHORIZED TO MAKE ANY CHANGE OR MODIFICATION TO THIS WARRANTY.

This warranty gives you specific legal rights, and you may also have other rights which vary from state to state.

### REPLACEMENT OF TOOL DUE TO NATURAL DISASTER

SENCO will replace any tool destroyed by an Act of God such as flood, earthquake, hurricane or other disaster resulting only from the forces of nature. Such a claim will be honored provided that such original retail purchaser had previously submitted a completed warranty registration card for the tool, and then submits proof of ownership and an acceptable statement describing such Act of God documented by an insurance carrier, police department, or other official governmental source. To obtain instructions for filing a claim call 1-800-543-4596.

### CUSTOMER SATISFACTION

One hundred percent customer satisfaction is our #1 goal. If for any reason the product does not perform to the original purchaser's satisfaction, it can be returned to the place of purchase **within thirty days** with dated sales receipt for a full refund of the purchase price.

# ***NOTES:***

# ***NOTES:***

# ***NOTES:***